

ROHS

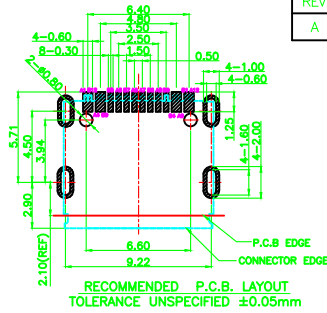
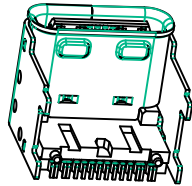
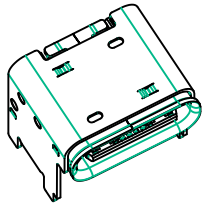

REV.	ECN. NO.	DESCRIPTION	ENG	DATE
A				

NOTES:

SPECIFICATION:

1. CURRENT RATING: 5.0A MAX
2. VOLTAGE: 100 VAC
3. TEMPERATURE RANGE: -30 °C ~ 85 °C
4. CONTACT RESISTANCE: 40 MILLIONHM MAX
5. INSULATION RESISTANCE: 100 MEGOHMS MIN.
6. INSERTION FORCE : 5N~20N
7. UNMATING FORCE: 8N~20N
8. DURABILITY: 10,000 CYCLES
9. Salt spray: 24H

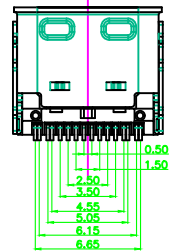
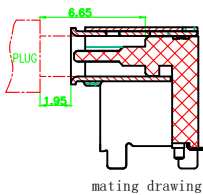
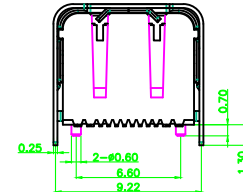
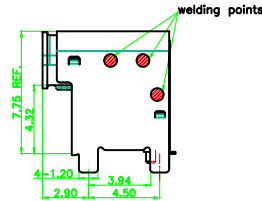
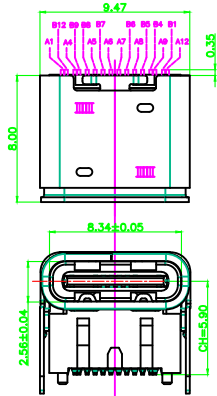
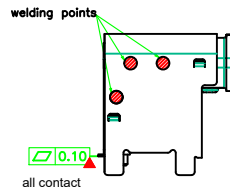

REFERENCE ONLY

PIN	SIGNAL NAME	PIN	SIGNAL NAME
A1	GND	B12	GND
A4	VBUS	B9	VBUS
A5	CC1	B8	SBU2
A6	DP1	B7	DN2
A7	DN1	B6	DP2
A8	SBU1	B5	CC2
A9	VBUS	B4	VBUS
A12	GND	B1	GND

NO.	DESCRIPTION	MATERIAL	REMARKS	QTY
7	OVER SHELL	STAINLESS STEEL SUS304	matte Ni Plated	
6	SHELL	STAINLESS STEEL SUS304	matte Ni Plated	1PCS
5	SHIELDING PLATE	STAINLESS STEEL SUS301	---	1PCS
4	MD	HIGH TEMPERATURE PLASTIC	BLACK	1PCS
3	CONTACT	COPPER ALLOY C7025-TOM	Au3 /Ni/Au1 U"	1SET
2	CONTACT	COPPER ALLOY C7025-TOM	Au3 /Ni/Au1 U"	1SET
1	HOUSING	HIGH TEMPERATURE PLASTIC	PA9T-BLACK	1PCS

DESIGN	MISS ZENG	SC ALL		
DRAWIGN	MISS LI	ANIT	MM	
CHECK	Mr. ZENG	SIZE	A4: 210*297	
APPROVAL		VERSION	01	

未注公差 TOLERANCE	
X. ±0.50	X". ±2"
X. ±0.30	X". ±1"
.XX ±0.20	.XX" ±0.5"
.XXX ±0.10	

品名: 连接器
 型号: CUSTOMER DRAWING
 C F 单排16P 架高型CH=5.90 母座

东莞市航宏电子科技有限公司
 Dongguan Hanghong Electronics Co., Ltd.